

Roger Select™ iN

User Guide



roger



A Sonova brand

PHONAK
life is on

Contents

1. Welcome	4	8. Using Roger Select iN with other Roger microphones	31
2. Getting to know your Roger Select iN	5	8.1 Connecting with other microphones	31
2.1 Device description	6	8.2 Using multiple microphones	33
2.2 Accessories	8	9. Troubleshooting	34
2.3 Indicator lights	10	10. Compliance information	37
3. Getting started	12	11. Information and explanation of symbols	41
3.1 Charging your Roger microphone	12	12. Important safety information	44
3.2 Switching Roger Select iN on	14	12.1 Hazard warnings	44
4. Using your Roger Select iN to hear better	15	12.2 Product safety information	47
4.1 Hearing better at a table	15	12.3 Other important information	48
4.2 Hearing a distant talker better	18	13. Service and Warranty	49
5. Listening to TV or other audio devices	21	13.1 Local warranty	49
5.1 Setting up the docking station	21	13.2 International warranty	49
5.2 Listening to the TV using the docking station	23	13.3 Warranty limitation	50
6. Listening to a portable audio device	25		
7. Additional functions	27		
7.1 Mute	27		
7.2 Connecting Roger Select iN to your Roger receiver	28		
7.3 Disconnecting Roger devices (NewNet)	30		
7.4 Reset	30		

1. Welcome

Your Roger Select iN has been developed by Phonak – the world leader in hearing solutions based in Zurich, Switzerland.

This premium product is the result of decades of research and expertise and is designed to keep you connected to the beauty of sound! We thank you for making such a great choice and wish you many years of listening pleasure.

Please read the user guide carefully to make sure that you understand and get the best out of your Roger Select iN. For more info, please contact your hearing care professional.

Phonak – life is on
www.phonak.com

2. Getting to know your Roger Select iN

Roger Select iN is a microphone that picks up the voice of a speaker and sends it wirelessly directly into your ears. You can place Roger Select iN in the middle of a table e.g. in a restaurant, or it can be worn by a single person i.e. to hear a distant talker.



i Your Roger Select iN typically works within a range of up to 10 meters / 33 feet to your hearing aids. Note that human bodies and walls may reduce this distance. The furthest range is possible when you can see your Roger Select iN (i.e. line of sight).

2.1 Device description

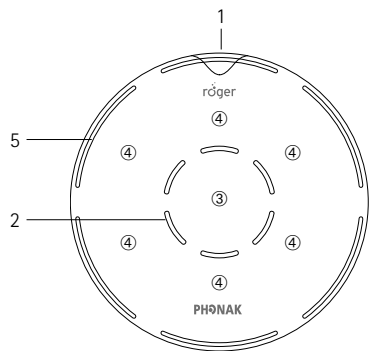

- 1 On/off button incl. battery status light
- 2 Microphones and center indicator lights
- 3 Center touch key
- 4 Six steering touch keys
- 5 Microphone mode indicator lights

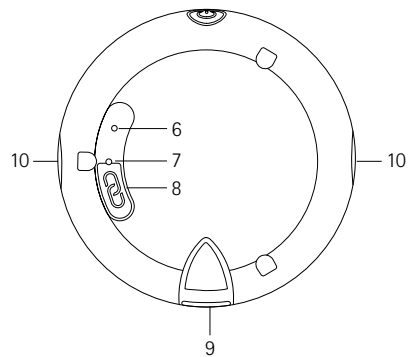

- 6 Reset button
- 7 Back indicator light
- 8 Connect button
- 9 Micro-USB socket
- 10 Slots for lanyard and clip

2.2 Accessories

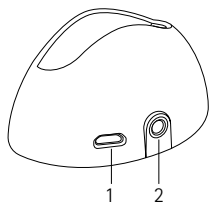

Docking station

- 1 External power supply input
- 2 Digital/analog audio input

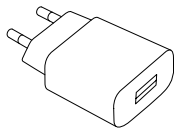

External power supply



Analog audio cable

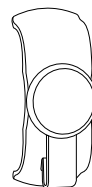

Magnetic clip

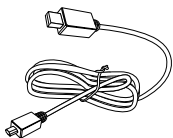

USB cable

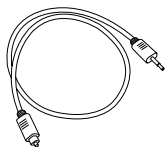

Digital audio cable



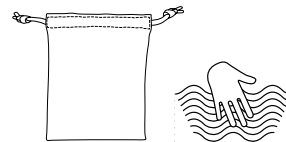

Lanyard

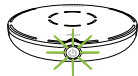

Pouch

2.3 Indicator lights

Battery status	Green fast blinking	Charging
	Green solid	Fully charged
	Green slow blinking	Switched on, battery full
	Orange blinking	Battery half full
	Red blinking	Battery empty, charge Roger Select iN
Microphone mode	Green all six segments	Microphone in all directions (all-around active)
	Green one to five segments	Microphone in selected directions active

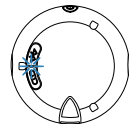
Mute	Redo solid	Microphone muted
	Red blinking	Unmute not possible, another Roger Select iN in the same network is active
Connect	Blue blinking	Connecting or pairing mode
	Solid green	Connecting / pairing successful
	Red double blinking	Connect timeout, move devices closer
	Red triple long blinking	Device not compatible

3. Getting started

3.1 Charging your Roger microphone

There are three ways to charge your Roger microphone:

A) Using external power supply: Plug the smaller end of the charging cable into your Roger microphone. Plug the larger end of the cable into the external power supply. Plug the external power supply into a wall outlet.

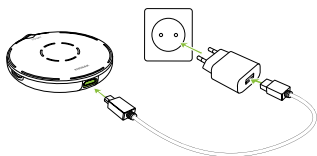

B) From computer or tablet: Plug the smaller end of the charging cable into your Roger microphone. Plug the larger end of the cable into the USB port on your computer and switch your computer on.

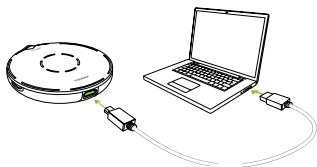

C) Via docking station: Slot the Roger Select iN into the docking station.

i Please read chapter 5.1 to setup the docking station.



Battery status light during charging

The battery status light around the on/off button will blink green until your Roger microphone is fully charged. When fully charged the battery status light will remain solid green .

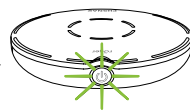

3.2 Switching Roger Select iN on

Press the  button 1 second until the microphone mode indicator light up.

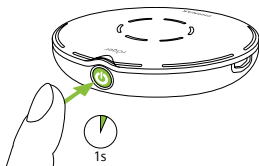

Battery status light after switching on

When your Roger microphone is switched on, the battery status light around the on/off button will blink softly. A green blinking light means that the battery is fully charged. A fully charged device lasts for approximately 8 hours. An orange blinking light means the battery is half full. If the indicator light starts to blink red, you should charge your Roger microphone immediately.



Please charge your Roger microphone

4. Using your Roger Select iN to hear better

Roger Select iN is a versatile, intelligent product. It detects which situation you are in and adapts its microphone settings automatically to provide you the best speech understanding possible.

 For best speech understanding, always bring your Roger microphone as close to the conversation partner(s) as possible.

4.1. Hearing better at a table

Place your Roger microphone in the middle of a table to listen to a group of people.



Your Roger microphone will activate an all-around microphone. When a talker speaks, your Roger microphone will focus its microphone to the talker and reduce the background noise.

If two or more people are speaking at the same time, you may tap a segment to focus on a specific person.

You can add other people by tapping additional segments.

Tapping an activated segment again will deactivate the selected direction.

To hear the whole group again, tap the center touch key.

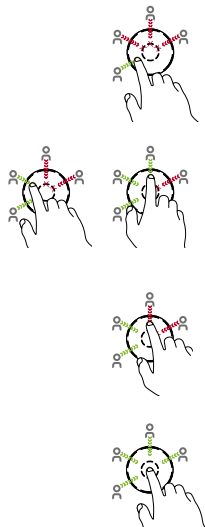

Microphone mode indicator lights

Each time you tap or move the device, the microphone mode indicator lights shows the active segments. The lights will fade out after a couple of seconds to save battery power.



All six directions are active



Selected directions active only

i In case there is no table, you can also hold your Roger microphone in your open palm. You can use the same functions as if it would be on the table.

4.2 Hearing a distant talker better

Roger Select iN allows you to hear a single conversation partner over distance or in very noisy environments. In typical conditions, you may hear the talker even if they are 10 meters / 33 feet away from you.

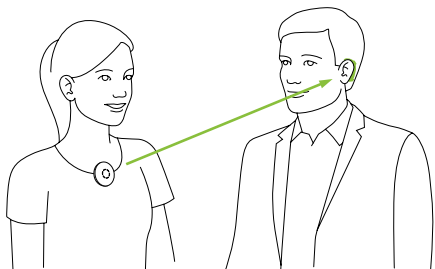

Attach the clip or lanyard before you give the device to the talker. Your Roger microphone automatically activates the appropriate microphone mode.

Using the clip

1) Attach the clip to your Roger microphone. Make sure the clip clicks into the small slots on the side of your Roger microphone.

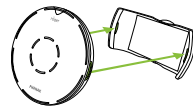

2) Open the magnetic clip.

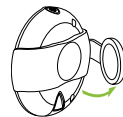

3) Attach the clip to the talker's shirt.



For best results, make sure your Roger microphone is worn in the middle of the chest, approx. 20 cm/8 inches from the mouth.

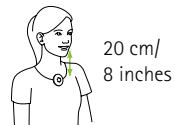

Using the lanyard

- 1) Attach the lanyard to your Roger microphone. Make sure the lanyard clicks into the small slots on the side of your Roger microphone.
- 2) Hang the lanyard around the neck of the talker and adjust the length so that your Roger microphone is within 20 cm/8 inches of the mouth.

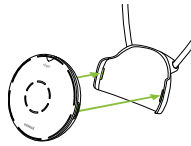

Microphone mode indicator lights

When Roger Select iN is worn by a talker, the top microphone mode indicator light will light up.



Removing the clip or lanyard

Press one side of the clip or lanyard to detach it from your Roger microphone.

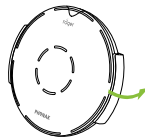

5. Listening to TV or other audio devices

5.1 Setting up the docking station

- 1) Insert the smaller end of the USB cable into the socket of the docking station.
- 2) Insert the larger end of the USB cable in the external power supply.
- 3) Plug the external power supply into the wall outlet.

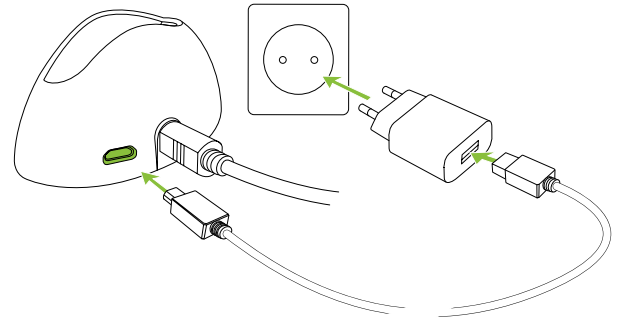

- 4) Connect the free end of the optical (Toslink) cable into the optical OUTPUT of your TV or alternative audio device.

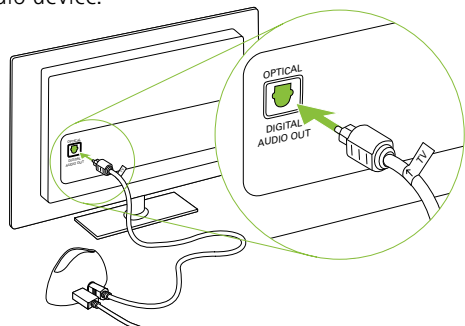

i If your TV or alternative audio device does not have optical audio output, you can alternatively use an analogue audio cable for connection between the TV and the docking station. The maximum audio output is 1.4 Vrms, higher audio input voltage may damage the device.

i Protect your eyes of the optical light from the optical Toslink cable when plugged into the device or TV.

5.2 Listening to the TV using the docking station

1) Insert your Roger microphone into the docking station. When it is placed into the docking station, it will automatically turn off.



2) Switch on your TV (or alternative audio device). Your Roger microphone will automatically transmit the audio signal to your ears.

To end the transmission of the audio signal, simply switch off the TV (or alternative audio device) or take your Roger microphone out of the docking station.

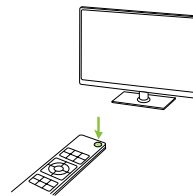

i The internal microphones of Roger Select iN will be muted when audio is transmitted. By pressing the center touch key, you can activate/deactivate the microphones of your Roger microphone (omnidirectional mic only).

Mute indicator lights

When your Roger microphone is placed in the docking station and transmitting audio, the center red indicator light appears.

Your Roger microphone transmits audio signals while its microphone is muted.

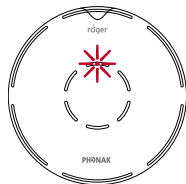

While transmitting audio, your Roger microphone also sends its microphone signal in parallel.

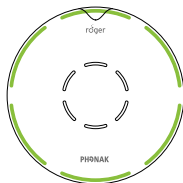

6. Listening to a portable audio device

- 1) Make sure you have switched on your Roger microphone.
- 2) Plug the rectangular end of the short audio cable into your Roger microphone.
- 3) Plug the round end of the short audio cable into the headphone output of your portable device.
- 4) Start the music or music app on your portable audio device.

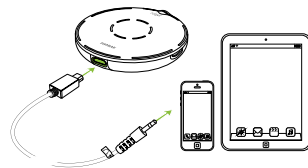

i Your Roger microphone will automatically mute when you plug the audio cable. You can activate the microphone by pressing the center touch key. Now you will hear the audio device and microphones in parallel.

To end the transmission of the audio signal, simply unplug the audio cable or switch your Roger microphone off.

Mute indicator lights

When the audio cable is plugged into your Roger microphone, the center red indicator light appears.

Your Roger microphone transmits audio signals while its microphone is muted.

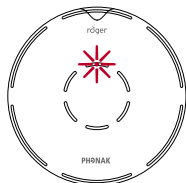

While transmitting audio, your Roger microphone also sends its microphone signal in parallel.

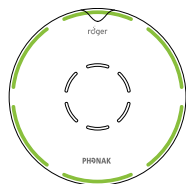

7. Additional functions

7.1 Mute

To mute the your Roger microphone, tap the center touch key of the device once or twice until the center red indicator light appears.

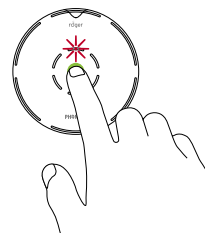

Tap the center touch key to re-activate the Roger microphone.

- ⓘ When the device is worn by a talker, the mute function cannot be used.

7.2 Connecting Roger Select iN to your Roger receiver

The Roger receiver can either be installed into your hearing aid, attached to your hearing aid / sound processor or body-worn (Roger MyLink or Roger X plugged into your streamer).

Connect the Roger receiver(s) as follows:



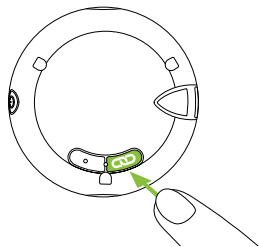

1. Turn on your Roger microphone and Roger receiver.
2. Hold your Roger microphone close (within 10 cm/ 4 inches) from the Roger receiver.
3. Press the Connect button  on your Roger microphone.



The back indicator light will turn green for two seconds to confirm a successful connection.

Connect status lights

After pressing the Connect button, the following feedback may be given by the back indicator light:

	Connecting
	Connection was successful – your Roger receiver is connected to your Roger microphone.
	Your Roger microphone could not find a Roger receiver. Move the devices closer to your Roger receiver and make sure the Roger receiver is powered on. Then try to connect again.
	The Roger receiver is not compatible with your Roger microphone.

i You can connect an unlimited number of Roger receivers to your Roger microphone, simply repeat step 2 and 3 for any other Roger receiver.

7.3 Disconnecting Roger devices (NewNet)

To disconnect your Roger microphone from any  connected receivers or other Roger microphones, hold the Connect button for 7 seconds. The back indicator light will turn orange when your Roger microphone has been disconnected from all connected devices.

7.4 Reset

If your Roger microphone stops responding to commands, you can reset it by pressing the on/off and reset buttons together for 10 seconds (you may need a thin paper-clip to press the reset button).

8. Using Roger Select iN with other Roger microphones

Roger Select iN can be combined with other Roger microphones, e.g. Roger Table Mic II. Using multiple microphones allows you to hear a bigger group or multiple distant speakers.

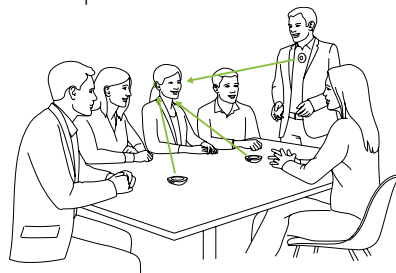

8.1. Connecting with other microphones

To connect another microphone to your Roger Select iN, follow these steps:

- 1) Turn on both microphones.
- 2) Hold the two microphones close together (within 10 cm/4 inches).
- 3) Press the connect button of Roger Select iN.

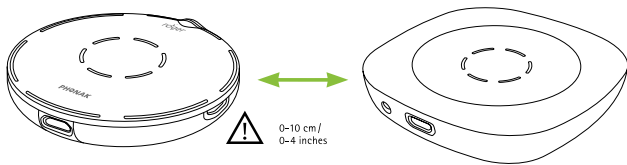

Connect status light

After pressing the Connect button, the following feedback may be given by the back indicator light:

-
-  Connection was successful - the other Roger microphone is now connected to your Roger Select iN.

 -  Roger Select iN could not find another Roger microphone. Move Roger Select iN closer to the other Roger microphone and make sure both microphones are switched on. Then try Connect again.

 -  The other Roger microphone is not compatible with your Roger Select iN or the other Roger Select iN's Bluetooth is still enabled. Please update the software of your Roger microphones or disable Bluetooth on the secondary Roger Select iN.
-

8.2. Using multiple microphones

When Roger Select iN is used with other microphones, it has to be worn by a talker on the chest. When you place Roger Select iN on the table, it will mute automatically. Unmuting Roger Select iN will mute the other microphones that are connected with the Roger Select iN. Muting Roger Select iN or wearing it on the chest will reactive the other microphones again.

9. Troubleshooting

Problem	Causes	Solutions
I cannot switch my Roger microphone on	The battery is empty	Charge your Roger microphone for at least two hours
I cannot hear from my Roger microphone	Your Roger microphone is muted (red LED)	Unmute your Roger microphone by pressing the center touch key
	Wrong direction is selected	Tap on the segment that is in the direction of the talker
	Your Roger receivers are not connected to your Roger microphone	Hold your Roger microphone close to each Roger receiver or Roger compatible hearing aid and press the Connect button
	Your Roger receiver is not working	Make sure you have attached the Roger receiver to your hearing aid and that it is powered on
	Your hearing aids are not set to the correct program	Check that your hearing aids are set to the correct program (Roger/FM/DAI/EXT)

Problem	Causes	Solutions
I can hear the talker but I cannot understand what he / she says	The microphone is too far from the talker	Move your Roger microphone closer to the talker's mouth
	The microphone openings are covered by fingers	Hold the microphone in a way that the microphone openings are not covered
	The microphone openings are covered by dirt	Clean the microphone openings
	Wrong direction is selected	Tap on the segment that is in the direction of the talker
I keep losing the audio signal	Distance between you and your Roger microphone is too far	Move closer to your Roger microphone
	There are obstacles between you and your Roger microphone	Try to be line of sight to your Roger microphone or go closer to your Roger microphone
I hear too much noise	Noise is picked up by your Roger microphone	Tap the segment in the direction of the talker to reduce background noise

Problem	Causes	Solutions
I do not like to hear my own voice over my Roger microphone	Your voice is picked up by your Roger microphone	Tap the segment in the direction of the talker to minimize your own voice pickup
The volume of my multimedia device is too low	Incorrect volume settings	Increase volume of your audio source
I cannot hear my multimedia device	The audio source is muted	Unmute the audio source
	your Roger microphone is switched off	Switch on your Roger microphone
My Roger microphone has stopped working and does not react to any button presses	The audio cable is not plugged correctly	Plug the audio cable correctly
	Software issue	Reboot your Roger microphone by simultaneously pressing the on/off and Connect button for 10 seconds

10. Compliance information

Europe: Declaration of Conformity

Hereby Phonak Communications AG declares that this product is in compliance with the Radio Equipment Directive 2014/53/EU. The full text of the EU Declaration of Conformity can be obtained from the manufacturer or the local Phonak representative or at www.phonak.com

Operation frequency: 2400 – 2483.5 MHz
Power level: < 100 mW

Australia/New Zealand:



R-NZ

Indicates a device's compliance with applicable Radio Spectrum Management's (RSM) and Australian Communications and Media Authority (ACMA) regulatory arrangements for the legal sale in New Zealand and Australia. The compliance label R-NZ is for radio products supplied in the New Zealand market under conformity level A1.

Notice 1:

This device complies with Part 15 of the FCC Rules and with Industry Canada's license exempt RSS standard(s).

Operation is subject to the following two conditions:

- 1) this device may not cause interference, and
- 2) this device must accept any interference, including interference that may cause undesired operation of the device.

Notice 2:

Changes or modifications made to this device not expressly approved by Phonak Communications AG may void the FCC authorization to operate this device.

Notice 3:

The device has been tested and found to comply with the limits for a Class B digital device, pursuant to Part 15 of the FCC Rules and ICES-003 of Industry Canada. These limits are designed to provide reasonable protection against harmful interference in a residential installation. The device generates uses and can radiate radio frequency energy and, if not installed and used in accordance with

the instructions, may cause harmful interference to radio communications. However, there is no guarantee that interference will not occur in a particular installation. If the device does cause harmful interference to radio or television reception, which can be determined by turning the device off and on, the user is encouraged to try to correct the interference by one of the following measures:

- Reorient or relocate the receiving antenna.
- Increase the separation between the device and receiver.
- Connect the device into an outlet on a circuit different from that to which the receiver is connected.
- Consult the dealer or an experienced radio/TV technician for help.

Notice 4:

Japanese Radio Law Compliance. Business Law Compliance. This device is granted pursuant to the Japanese Radio Law (電波法). This device should not be modified (otherwise the granted designation number will become invalid).

Notice 5:

FCC / Industry Canada RF Radiation Exposure Statement
This device complies with FCC RF radiation exposure limits set forth for an uncontrolled environment. This transmitter must not be co-located or operating in conjunction with any other antenna or transmitter.

11. Information and explanation of symbols



The CE symbol is confirmation by Phonak Communications AG that this product is in compliance with the Radio Equipment Directive 2014/53/EU.



This symbol indicates that it is important for the user to read and take into account the relevant information in this user guide.



Indicates the device manufacturer.



This symbol indicates that it is important for the user to pay attention to the relevant warning notices in this user guide.



Important information for handling and product safety.

Operating conditions

The device is designed such that it functions without problems or restrictions if used as intended, unless otherwise noted in this user guide.



Temperature transport and storage: -20° to +60° Celsius (-4° to +140° Fahrenheit). Temperature operation: 0° to +40° Celsius (+32° to +104° Fahrenheit).



Keep dry.



Humidity during transportation and storage: <90% (non-condensing). Humidity operation: <90% (non-condensing).



Atmospheric pressure: 200 hPa to 1500 hPa.



This symbol on the product or its packaging means that it should not be disposed of with your other household waste. It is your responsibility to dispose of your waste equipment separately from the municipal waste stream. The correct disposal of your old appliance will help prevent potential negative consequences for the environment and human health. This product has an embedded, nonreplaceable battery. Do not attempt to open the product or remove the battery as this may cause injury and damage the product. Please contact the local recycling facility for removal of the battery.



Dolby, Dolby Audio, and the double-D symbol are trademarks of Dolby Laboratories.

12. Important safety information

Please read the information on the following pages before using your device.

12.1 Hazard warnings

⚠ This device is not for children below 36 months. It contains small parts that can cause choking, if swallowed by children. Keep out of reach of children and mentally challenged people or pets. If swallowed, consult a physician or hospital immediately.

⚠ The device may generate magnetic fields. If any influence of the Roger Select iN on the Implantable Device (e.g. pacemakers, defibrillators, etc.) is experienced, stop using the Roger Select iN and contact your doctor and /or the manufacturer of the Implantable device for advice.

⚠ Use only hearing aids that have been specially programmed for you by your hearing care professional.

⚠ Dispose of electrical components in accordance with your local regulations.

⚠ Changes or modifications to any of the devices that were not explicitly approved by Phonak Communication AG are not permitted.

⚠ Only use accessories approved by Phonak Communication AG.

⚠ The charger provided by Phonak Communications AG can be used for charging Roger Select iN up to 5000m altitude. For safety reasons, only use chargers supplied by Phonak Communications AG or certified chargers with a rating of 5VDC, max. 2000 mA and up to a maximum altitude of 2000m.

⚠ Do not use the device in explosive areas (mines or industrial areas with danger of explosions, oxygen rich environments or areas where flammable anesthetics are handled) or where electronic equipment is prohibited.

- ⚠ Opening the device might damage it. If problems occur which cannot be resolved by following the remedy guidelines in the troubleshooting section of this user guide, consult your hearing care professional.
- ⚠ When operating machinery, ensure that no parts of your device can get caught in the machine.
- ⚠ Do not charge device while it is on your body.

12.2 Product safety information

- ① Protect the device connectors, plugs, power supply from dirt and debris.
- ① Do not use excessive force when connecting your device to its different cables.
- ① Protect the device from excessive moisture (bathing or swimming areas) and heat sources (radiator). Protect the device from excessive shock and vibration.
- ① Clean the device using a damp cloth. Never use household cleaning products (washing powder, soap, etc.) or alcohol to clean them. Never use a microwave or other heating devices to dry the device.
- ① X-ray radiation, CT or MRI scans may destroy or adversely affect the correct functioning of the device.

- ❗ If the device has been dropped or damaged, if it overheats, has a damaged cord or plug, or has been dropped into liquid, stop using your device and contact authorized service centre.

12.3 Other important information

- ❗ Protect your eyes of the optical light from the optical Toslink cable when plugged into the device or TV.
- ❗ High-powered electronic equipment, larger electronic installations and metallic structures may impair and significantly reduce the operating range.
- ❗ Device collects and stores internal technical data. This data may be read by a hearing care professional in order to check the device, as well as to help you use your device correctly.
- ❗ The digital signal sent from the device to a connected receiver cannot be overheard by other devices which are not in the microphone's network.

13. Service and warranty

13.1 Local warranty

Please ask the hearing care professional, where you purchased your devices, about the terms of the local warranty.

13.2 International warranty

Phonak offers a one year limited international warranty, valid as of the date of purchase. This limited warranty covers manufacturing and material defects. The warranty is valid only if proof of purchase is shown.

The international warranty does not affect any legal rights that you might have under the local warranty or the applicable national legislation governing sale of consumer goods.



Phonak Communications AG
Länggasse 17
CH-3280 Murten
Switzerland
www.phonak.com



029-0755-02/V1.00/2019-01/na © 2019 Sonova AG All rights reserved

sonova
HEAR THE WORLD

